

KENWOOD

CD PLAYER

CD/DPF-R SERIES

CD-206 DPF-R6010

CD-204 DPF-R4010

CD-203 DPF-R3010

INSTRUCTION MANUAL

KENWOOD CORPORATION

This instruction manual is used for six models. Model availability and features (functions) may differ depending on the country and sales area.

DTS disclaimer clause

When Playing DTS-encoded CDs, excessive noise will be exhibited from the analog stereo outputs. The consumer should take proper precautions when the analog stereo outputs of the CD player is connected to an amplification system. To enjoy DTS Digital Surround playback, an external 5.1 channel DTS Digital Surround decoder system must be connected to the digital output (S/PDIF, ASE/EBU, or TosLink) of the CD player.



Introduction

CD-206/204/203/DPF-R6010/R4010/R3010 (En)

2 Before applying power

⚠ Caution : Read this section carefully to ensure safe operation.

Units are designed for operation as follows.

U.S.A. and Canada AC 120 V only
Australia AC 240 V only

U.K. and Europe AC 230 V only
China AC 220 V only
*Other countries AC 110-120 / 220-240 V switchable

*AC voltage selection

The AC voltage selector switch on the rear panel is set to the voltage that prevails in the area to which the unit is shipped. Before connecting the power cord to your AC outlet, make sure that the setting position of this switch matches your line voltage. If not, it must be set to your voltage in accordance with the following direction.

Note:
Our warranty does not cover damage caused by excessive line voltage due to improper setting of the AC voltage selector switch.

AC voltage selector switch

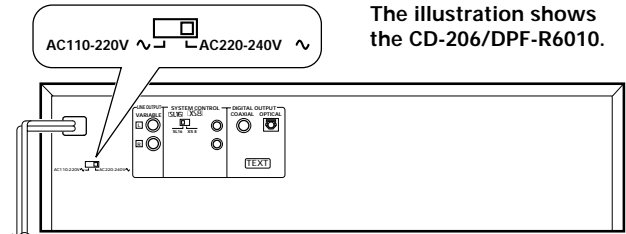

Move switch lever to match your line voltage with a small screwdriver or other pointed tool.

For the United Kingdom

Factory fitted moulded mains plug

1. The mains plug contains a fuse. For replacement, use only a 13-Amp ASTA-approved (BS1362) fuse.
2. The fuse cover must be refitted when replacing the fuse in the moulded plug.
3. Do not cut off the mains plug from this equipment. If the plug fitted is not suitable for the power points in your home or the cable is too short to reach a power point, then obtain an appropriate safety approved extension lead or adapter, or consult your dealer.
If nonetheless the mains plug is cut off, remove the fuse and dispose of the plug immediately, to avoid a possible shock hazard by inadvertent connection to the mains supply.

IMPORTANT

The wires in the mains lead are coloured in accordance with the following code:

- Blue : Neutral
- Brown : Live

Do not connect those leads to the earth terminal of a three-pin plug.

Safety precautions

⚠ Caution : Read this section carefully to ensure safe operation.

WARNING : TO PREVENT FIRE OR ELECTRIC SHOCK, DO NOT EXPOSE THIS APPLIANCE TO RAIN OR MOISTURE.

	CAUTION RISK OF ELECTRIC SHOCK DO NOT OPEN		CAUTION: TO REDUCE THE RISK OF ELECTRIC SHOCK, DO NOT REMOVE COVER (OR BACK). NO USER-SERVICEABLE PARTS INSIDE. REFER SERVICING TO QUALIFIED SERVICE PERSONNEL.
	THE LIGHTNING FLASH WITH ARROWHEAD SYMBOL, WITHIN AN EQUILATERAL TRIANGLE, IS INTENDED TO ALERT THE USER TO THE PRESENCE OF UNINSULATED "DANGEROUS VOLTAGE" WITHIN THE PRODUCT'S ENCLOSURE THAT MAY BE OF SUFFICIENT MAGNITUDE TO CONSTITUTE A RISK OF ELECTRIC SHOCK TO PERSONS.		
	THE EXCLAMATION POINT WITHIN AN EQUILATERAL TRIANGLE IS INTENDED TO ALERT THE USER TO THE PRESENCE OF IMPORTANT OPERATING AND MAINTENANCE (SERVICING) INSTRUCTIONS IN THE LITERATURE ACCOMPANYING THE APPLIANCE.		

REQUIREMENT BY NEDERLAND GAZETTE

Batteries are supplied with this product. When they empty, you should not throw away. Instead, hand them in as small chemical waste.

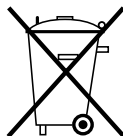

The marking of products using lasers (Except for some areas)

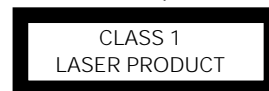

The marking is located on the rear panel and says that the component uses laser beams that have been classified as Class 1. It means that the unit is utilizing laser beams that are of a weaker class. There is no danger of hazardous radiation outside the unit.

Unpacking

Unpack the unit carefully and make sure that all accessories are put aside so they will not be lost.

Examine the unit for any possibility of shipping damage. If your unit is damaged or fails to operate, notify your dealer immediately. If your unit was shipped to you directly, notify the shipping company without delay. Only the consignee (the person or company receiving the unit) can file a claim against the carrier for shipping damage.

We recommend that you retain the original carton and packing materials for use should you transport or ship the unit in the future.

Keep this manual handy for future reference.

Special features

CD-TEXT support (CD-206/DPF-R6010 only)

- The text information (disc title, track titles, names of the artists, songwriters, composers, etc.) recorded on the CDs can be easily called and displayed in alphanumerics. (Some words and text may not be displayed.) → 12 → 13

Advanced technologies incorporated in pursuit of improved sound quality and stability (CD-206/DPF-R6010 only)

- D.R.I.V.E. (Dynamic Resolution Intensive Vector Enhancement) IC is built in for drastic reduction of distortion at small signal level.

Convenient features for dubbing CD onto tape

- Normal EDIT: Edit function for rearranging tracks according to the tape length so that no music is interrupted in the middle. → 20
- MULTI EDIT: Several CDs can be edited and recorded on 1 tape. (Except for CD-206/DPF-R6010) → 21
- Auto space function. → 16

Easy operation functions

- Easy operation functions allow systematic operation with other KENWOOD components connected through the system control connection. → 5

Accessories

Audio cord (1)



System control cord (1)

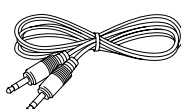

AC plug adaptor (1)

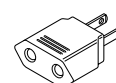

Remote control unit (1)
(Except for CD-203/DPF-R3010)

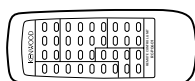

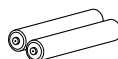

Batteries (R6/AA) (2)
(Except for CD-203/DPF-R3010)



Use to adapt the plug on the power cord to the shape of the wall outlet. (Accessory only for regions where use is necessary.)

Contents

Caution: Read the pages marked  carefully to ensure safe operation.

Introduction	2	Displays	13
 Before applying power	2	Programmed play (PGM mode)	14
 Safety precautions	2	Playback in random order (Random playback)	17
Special features	3	Repeated playback	18
System connections	4	Editing	20
Controls and indicators	6	Normal EDIT	20
Operation of remote control unit	8	MULTI EDIT	21
Preparing to play tracks	9	Timer operations	23
Normal play (TRACK mode)	10	Maintenance	24
Searching for tracks by title (TITLE SEARCH)	12	In case of difficulty	25
		Specifications	26

System connections

CD-206/204/203/DPF-R6010/R4010/R3010 (En)

4

Caution:

Do not plug in the power lead until all connections are completed.

Malfunction of microcomputer

If operation is not possible or erroneous display appears even though all connections have been made properly, reset the microcomputer referring to "In case of difficulty".

Make connections as shown below.
When connecting the related system components, refer also to the instruction manuals of the related components.

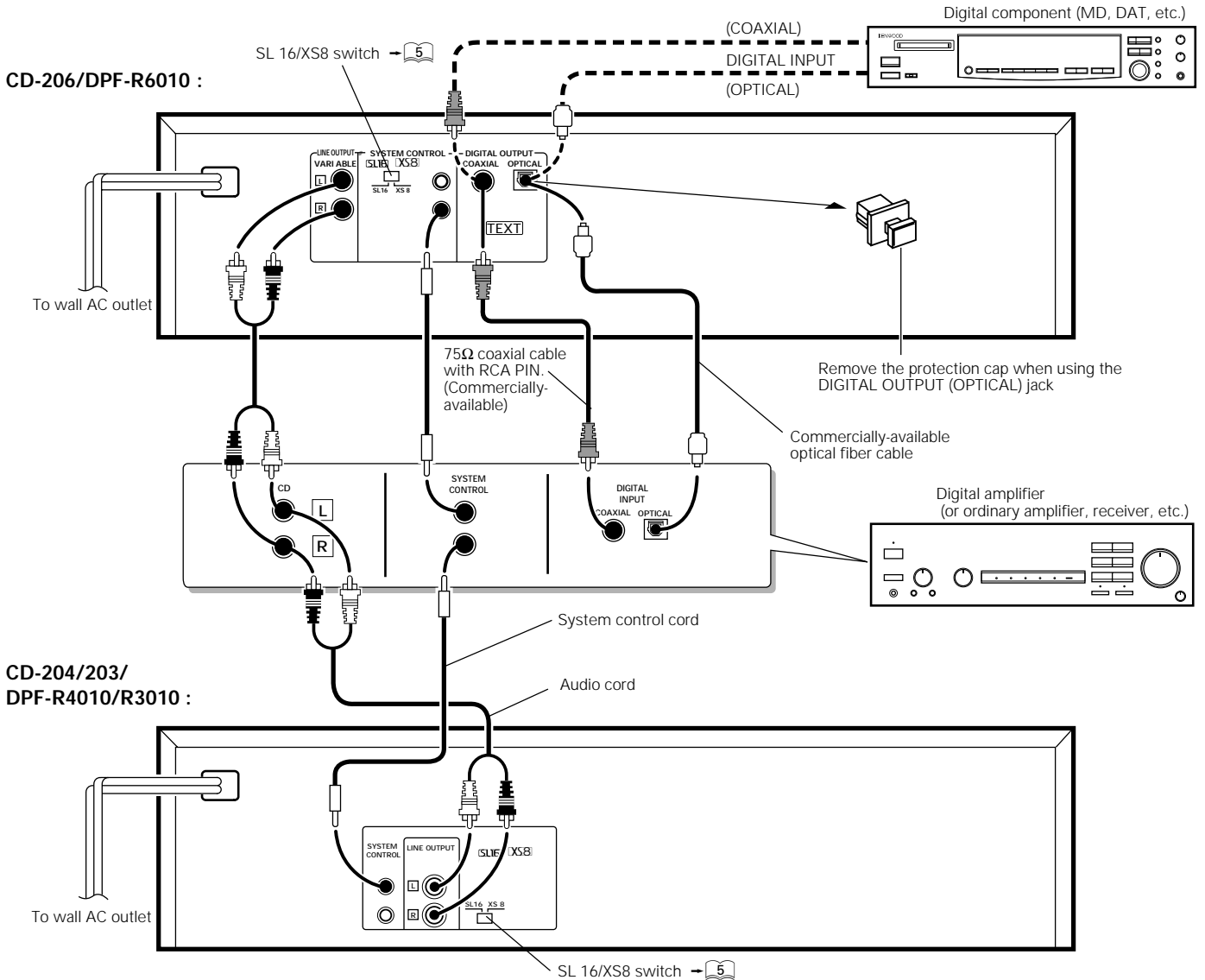

Connection to digital amplifier or MD (CD-206/DPF-R6010 only)

Connect the DIGITAL OUTPUT (OPTICAL or COAXIAL) jack to the digital input jack of the amplifier, DAT recorder, MD recorder, etc., using an optical fiber cable or coaxial cable which are commercially available in audio stores.

- When using an optical fiber cable to connect this unit to a digital amplifier, insert the plug straight into the jack until a snap sound is heard.
- Be careful not to bend, coil, or bundle the optical fiber cable.
- Optical fiber cables available on the market may not always be able to be used with this player. If your cord cannot be used with this unit, consult the store from which you purchased the cord or your nearest dealer.

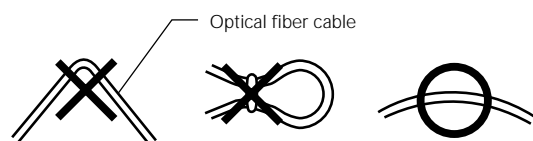

1. Connect all cords firmly. If connections are loose there could be loss of sound or noise produced.
2. When plugging and unplugging connection cords, be sure to first remove the power cord from the AC outlet. Plugging/unplugging connection cords without removal of the power cord can cause malfunctions or damage to the unit.

SYSTEM CONTROL CONNECTIONS

Connecting system control cords after connecting a KENWOOD audio component system lets you take advantage of convenient system control operations.

There are two KENWOOD system control modes. Make connections according to the groups of terminal symbols shown below.

[XS 8] Mode : lets you combine [XR], [XS], and [XS8] terminals

[SL16] Mode : for [SL16] terminals only

This unit is compatible with both [XS8] and [SL16] modes. Select the mode according to the connected components. → 4

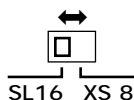

- Do this operation after completing all connections. (Ensure that the unit is set to STANDBY mode.)

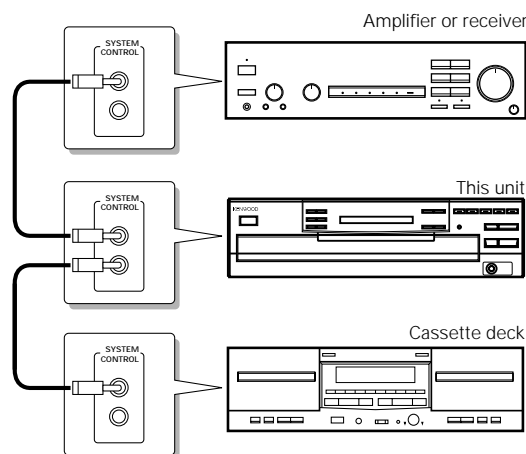

- If your amplifier or receiver does not have a system control terminal, do not connect any system control cords to the system control terminals on the other components.
- Do not connect system control cords to any components other than those specified by KENWOOD. It may cause a malfunction and damage your equipment.
- Be sure the system control plugs are inserted all the way in to the system control terminals.

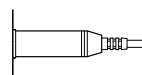

SYSTEM CONTROL OPERATIONS

Remote Control

Lets you operate this unit with the system remote control unit supplied with the amplifier or receiver.

Automatic Operation (Except [XR] equipment)

Automatically switches the input selector on the amplifier or receiver when you start playback from this unit.

Synchronized Recording (Except [XR] equipment)

Lets you synchronize recording with the start of playback when recording from a CD. Also, the simple CCRS operation enables great recordings from CDs.

See the operating instructions supplied with your cassette deck for details.

Adjusting the output levels of the output jacks and headphone output (Except for CD-203/DPF-R3010)

The OUTPUT level (UP/DOWN) keys of the remote control unit can adjust the output levels from the LINE/OUT and PHONES jacks of the unit.

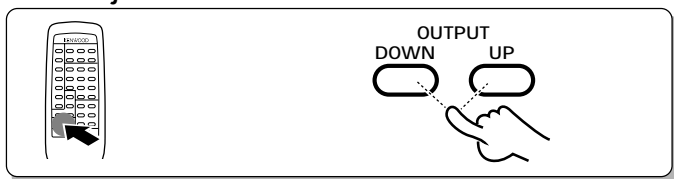

- It is not favorable for the sound quality to decrease the output level from this unit too much. Use these keys for coordination with other line levels.
- Adjusting the headphone output level also changes the LINE/OUT level. Do not adjust the output level from this unit particularly during recording.
- Please note that the sound output is at the maximum level when the power is turned on.

To use the headphone (Except for CD-203/DPF-R3010)

Connect a stereo headphone to the PHONES jack of the CD player. Adjust the sound volume using the remote control unit.

CD-206/DPF-R6010

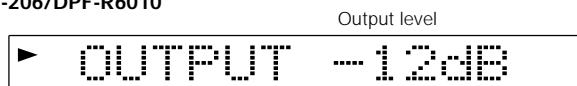

CD-204/DPF-R4010

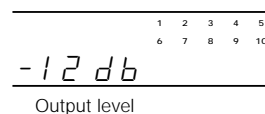

CD-206/DPF-R6010

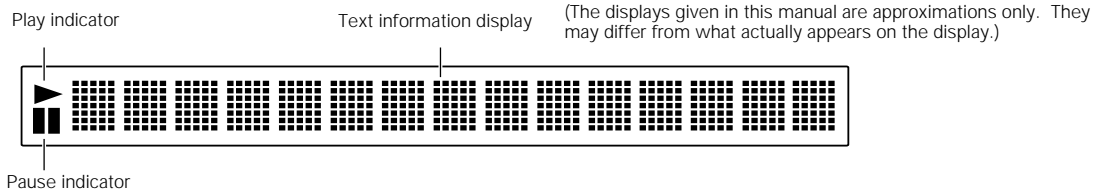

CD-204/203/DPF-R4010/R3010

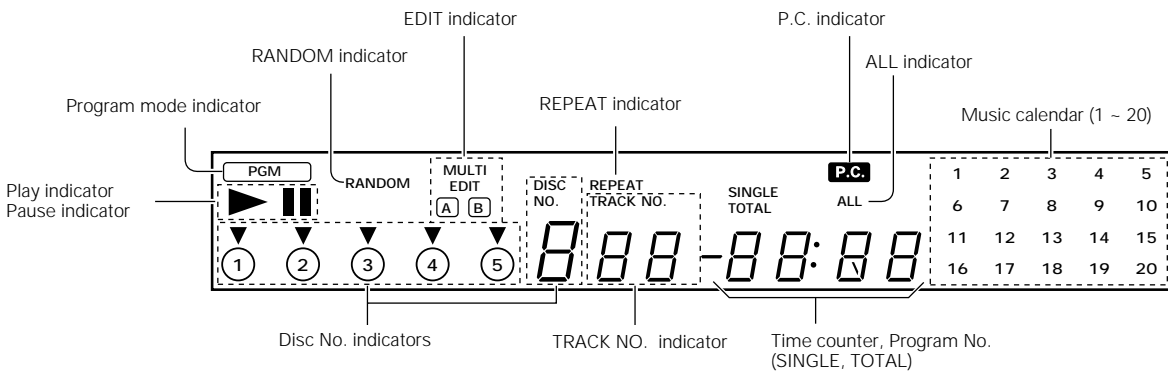



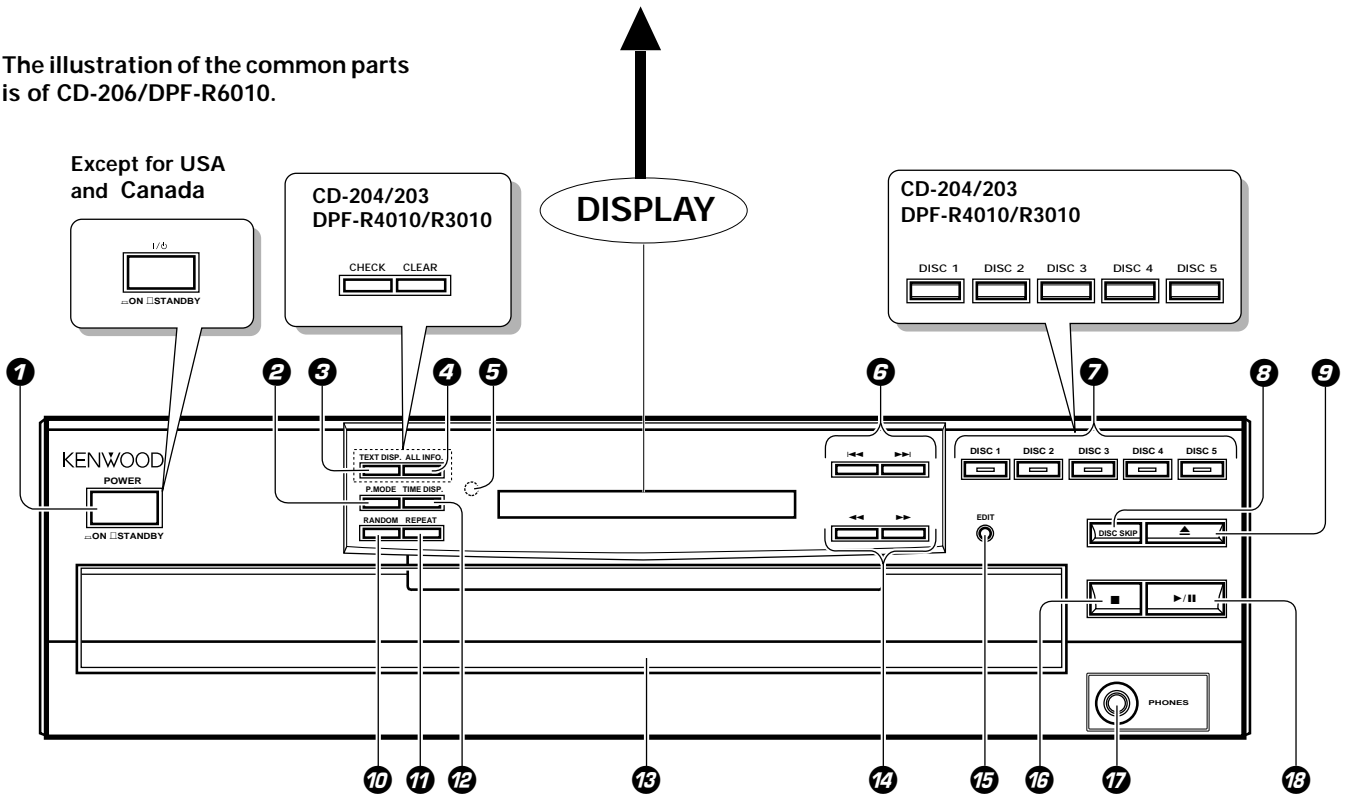





The illustration of the common parts is of CD-206/DPF-R6010.



About the *STANDBY* mode

When the power cord of this unit is plugged into an AC outlet, a small amount of current is being supplied to the unit even when the ON/STANDBY switch is not depressed (□). This is called the *STANDBY* mode.

The keys with the same name as those on the remote control unit operate the same way as the remote control unit.

- | | | | |
|---|--|---|--|
| 1 ON/STANDBY (POWER / I / ⏻) switch | →  9 | 9 Open/Close key (▲) | →  9 |
| Turns the unit ON/STANDBY. | | Opens and closes the disc tray. | |
| 2 P.MODE key | →  14 | 10 RANDOM key | →  17 |
| 3 TEXT DISP. key (CD-206/DPF-R6010 only) | →  13 | Press to play the tracks in a random order. | |
| Used to select the CD-TEXT information display. | | 11 REPEAT key | →  18 |
| CHECK key (CD-204/203/DPF-R4010/R3010 only) | →  15 | Press to play the tracks repeatedly. | |
| Used to check or change program contents. | | 12 TIME DISP. key | →  16 |
| 4 ALL INFO. key (CD-206/DPF-R6010 only) | →  13 | Press to switch the time indication mode. | |
| Used to display all text information on the CD. | | 13 Disc tray | →  9 |
| CLEAR key (CD-204/203/DPF-R4010/R3010 only) | →  16 | Load the disc to be played back. | |
| Used to clear the program. | | 14 Search keys (◀◀, ▶▶) | →  11 |
| 5 Remote control light sensor (CD-206/204/DPF-R6010/R4010 only) | →  8 | Fast forwards or fast reverses the track. | |
| 6 Skip keys (◀◀, ▶▶) | →  11 | 15 EDIT mode key | →  20 |
| Press to skip to the beginning of another track. | | Press to select the edit mode. | |
| 7 Disc selector keys (DISC1 – DISC5) / Indicator (CD-206/DPF-R6010 only) | →  10 | 16 STOP key (■) | →  10 |
| Press to select the disc to be played. | | 17 PHONES jack (CD-206/204/DPF-R6010/R4010 only) | →  5 |
| 8 DISC SKIP key | →  9 | Use to connect (optional) headphones. | |
| Press to rotate the disc tray or to select the disc. | | 18 PLAY/PAUSE key (▶/) | →  10 |
| | | Each time the key is pressed, playback and pause switch each other. | |

Operation of remote control unit (Except for CD-203/DPF-R3010)

CD-206/204/203/DPF-R6010/R4010/R3010 (En)

The illustration shows the RC-P0601.

The keys with the same name as those on the main unit operate the same way as on the main unit. The keys marked * are provided only on the remote control unit.

8

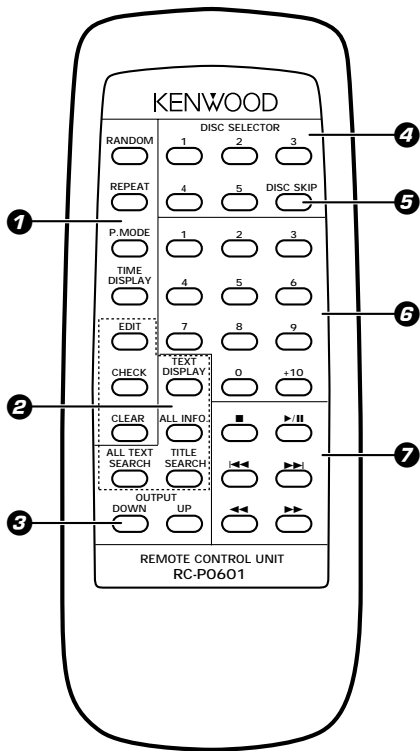

1 Program-related and other keys RANDOM key → 17 REPEAT key → 18 P.MODE key → 14 TIME DISPLAY key → 16 EDIT key → 20 * CHECK key (CD-206/DPF-R6010 only) → 15 → 22 * CLEAR key (CD-206/DPF-R6010 only) → 16 → 22	* 3 OUTPUT (DOWN, UP) key → 5
2 Selector keys relating to text information (CD-206/DPF-R6010 only) * ALL TEXT SEARCH key → 9 TEXT DISPLAY key → 13 ALL INFO. key → 13 * TITLE SEARCH key → 12	4 DISC SELECTOR keys → 10 5 DISC SKIP key → 9 → 10
	* 6 Numeric keys (1 - 0, +10) → 11
	7 Basic function keys Stop key (■) → 10 Play/Pause key (▶/) → 10 Skip (◀◀, ▶▶) keys → 11 Search keys (◀◀, ▶▶) → 11

CD-206/DPF-R6010 :
Model: RC-P0601
Infrared ray system

CD-204/DPF-R4010 :
Model: RC-P0504
Infrared ray system

Loading batteries

1 Remove the cover.

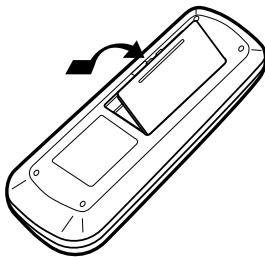

2 Insert batteries.

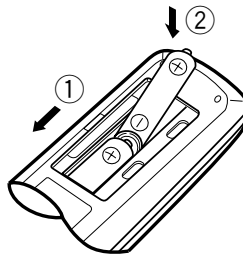

● Insert two AA-size (R6) batteries as indicated by the polarity marking.

3 Close the cover.

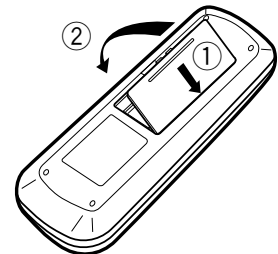

Operation

After plugging in the power cord, press the ON/STANDBY (POWER/ I / ⏻) switch of the main unit to turn the unit ON. When the unit is turned ON, press the key of the function to be operated.

● When pressing more than one remote control key successively, press the keys securely by leaving an interval of 1 second or more between keys.

Remote control light sensor

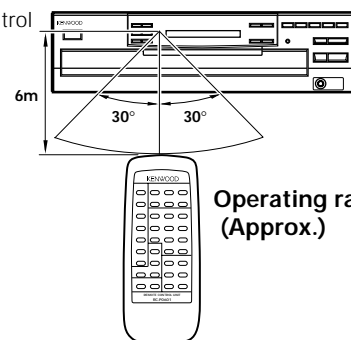

Operating range (Approx.)



1. The supplied batteries are intended for use in operation checks. Therefore, their lives may be shorter than ordinary batteries.
2. When the remote-controllable distance gets shorter than before, replace both batteries with new ones.
3. Malfunction may occur if direct sunlight or the light of a high-frequency lighting fluorescent lamp enters the remote control light sensor. In such a case, change the system installation position to prevent the malfunction.

Preparing to Play Tracks

Preparation

• Turn the unit ON.

Press the ON/STANDBY (POWER / I/⏻) key.

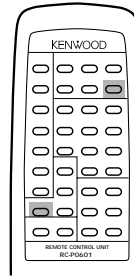
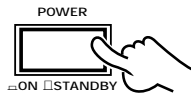

Hereafter the illustration of the common parts on the front panel is of CD-206/DPF-R6010.

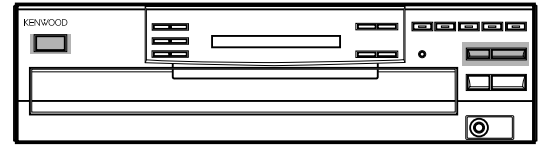

: Keys and controls used in the operations described on this page.

Loading/unloading discs

1 Load/unload a disc.

1 Open the tray.

2 Place/remove a disc.

3 When loading or unloading other discs

- Do not touch the played side of disc.
- Loading two discs together will cause malfunctioning.
- Place the disc properly along the groove on the tray. (If the disc is not placed horizontally, malfunction will result.)
- A single CD (8 cm disc) can also be played.
- Ordinary CD single (8 cm) disc adapters sold in audio stores cannot be used with this unit.

- When loading/unloading a disc while the tray rotates, a malfunction might occur. Load/unload the disc when the tray does not rotate.

2 Close the tray.

CD-206/DPF-R6010



All DISC indicators " " light regardless of how many discs are present.

CD-204/203/DPF-R4010/R3010



All DISC indicators " o " light regardless of how many discs are present.

ALL TEXT SEARCH (CD-206/DPF-R6010 only)

Remote control unit only

For most CD-TEXT discs, it is convenient to read the complete disc information into the CD player before playing the disc. This allows text information such as TITLE SEARCH, TEXT DISPLAY, ALL INFO., and other messages to be displayed faster.

After loading all the discs, operate in stop mode.

ALL TEXT SEARCH

- The information read into the CD player is cleared when the tray is opened. Therefore, perform this operation again if the tray was opened.

Search in progress or reading information

Blinks.



When the disc is CD-TEXT

- Repeat the above procedure so that the complete disc information is read into the CD player.
- In the case of a non-CD-TEXT disc, the "D1 : NO CD TEXT" display will appear for approx. 3 seconds.

Normal play (TRACK mode)

CD-206/204/203/DPF-R6010/R4010/R3010 (En)

10

Use the following procedure to play a CD in the original order of tracks from track No. 1.

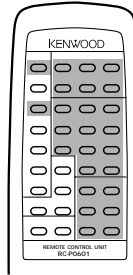

Hereafter the illustration of the common parts on the front panel is of CD-206/DPF-R6010.

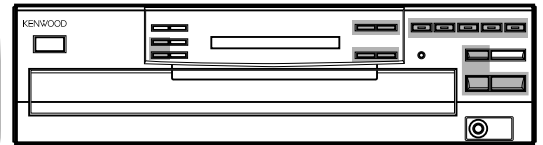

 : Keys and controls used in the operations described on this page.

Playing tracks in order from track No. 1

1 Check that the unit is in the normal play TRACK mode. 

2 Start playback.

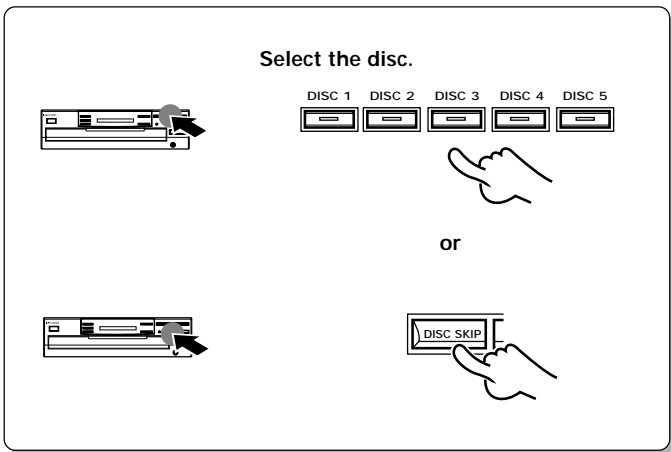

CD-206/DPF-R6010

If there is no disc in the selected disc tray, the corresponding indicator "  " goes off.

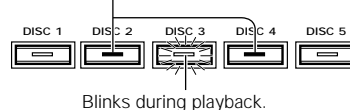

CD-204/203/DPF-R4010/R3010

If there is no disc in the selected disc tray, the corresponding indicator "  " goes off.

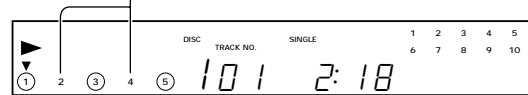

- Playback starts from the disc selected in order of the DISC No.
- When the  key is pressed without selecting a disc, playback starts from the indicated DISC No.

CD-206/DPF-R6010

Lights up.



Track NO. being played

Elapsed time of track being played

- In the case of a CD-TEXT disc, the disc's title is scrolled on the display. What is then displayed is in accordance with the **TEXT DISPLAY** mode.



CD-204/203/DPF-R4010/R3010



Disc indicator during Playback ()

Track NO. being played

Elapsed time of track being played

To pause playback

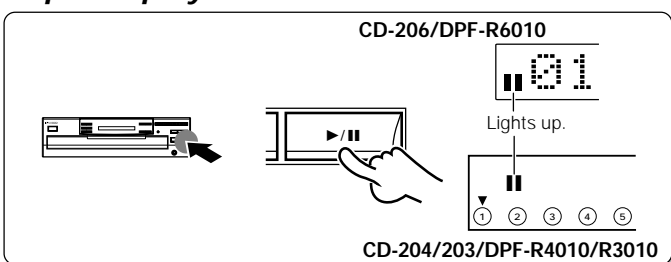

- Each press pauses and plays the CD alternately.

To stop playback

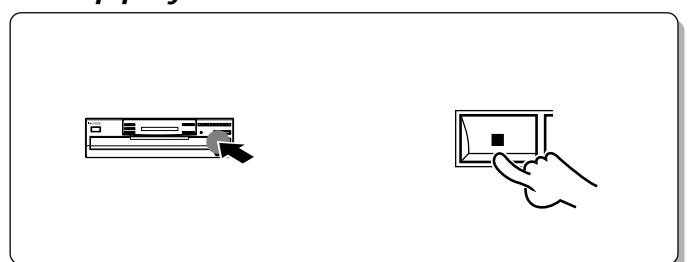

Playback from desired track

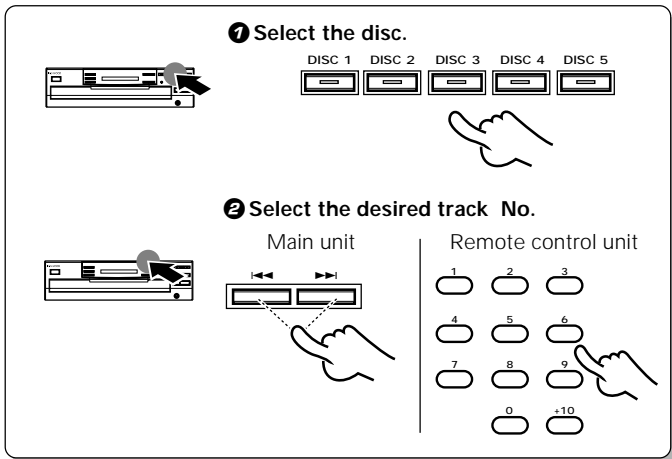

Press the numeric keys as shown below....

To enter track No. 23 : **+10 +10 3**
 To enter track No. 40 : **+10 +10 +10 +10 0**

- Playback starts from the selected track and continues on the subsequent tracks.

Skipping tracks

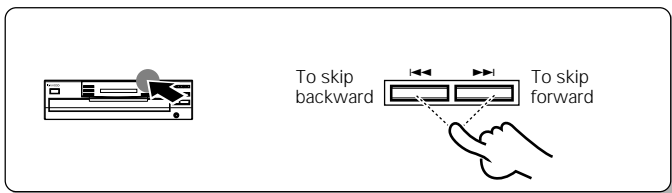

- The track in the direction of the pressed key is skipped, and the selected track will be played from the beginning.
- When the **◀◀** key is pressed once during playback, the track being played will be played from the beginning.

Searching

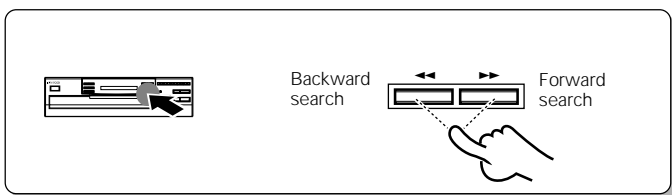

- Playback starts from the position where the key is released.

What is the "normal play TRACK mode"?

The normal play TRACK mode refers to the state in which the PGM, EDIT and RANDOM mode displays are off.

To set the unit to the TRACK mode:

- Press the **P.MODE** key when the "PGM" or "EDIT" display is lighted.
- Press the **RANDOM** key when the "RNDM" display is lighted.

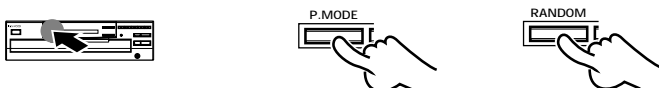

CD-206/DPF-R6010

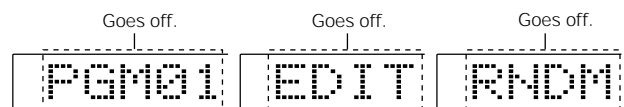

CD-204/203/DPF-R4010/R3010





Searching for tracks by title (TITLE SEARCH) (CD-206/DPF-R6010 only)

CD-206/204/203/DPF-R6010/R4010/R3010 (En)

12

In the case of a CD-TEXT disc, the tracks to be heard can be searched by title.

Preparation

- Load a disc (CD-TEXT support) in the CD player.
- Check that the unit is in the normal play TRACK mode.  11
- Press the **ALL TEXT SEARCH** key.  9

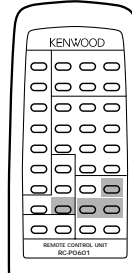

Hereafter the illustration of the common parts on the front panel is of CD-206/DPF-R6010.

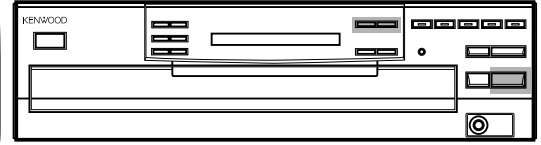

 : Keys and controls used in the operations described on this page.

1 Press the TITLE SEARCH key.



TITLE SEARCH

To stop the search, press the **TITLE SEARCH** key again.

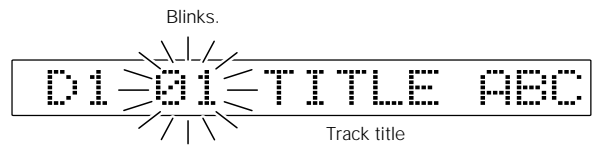

- When no CD-TEXT discs are loaded, the "NO CD TEXT" display will appear for approx. 3 seconds.

2 Select the name of the track (title) to be heard.



The track number skips backward.

The track number skips forward.

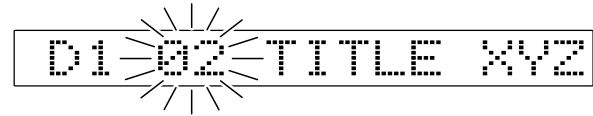

If no keys are operated for more than a second, the track title is scrolled on the display.

3 Start playback.

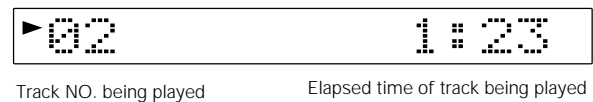
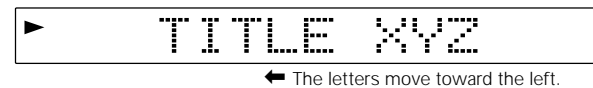



- What is displayed will differ depending on the item which has been selected by **TEXT DISPLAY**.  13

Display scrolling

Some track titles contain so much text information that the full titles will not fit on the display. In cases like this, the letters on the display move from right to left so that the non-visible part of the title is revealed. This type of display movement is known as "scrolling display."

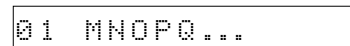
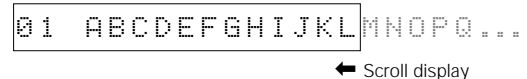
Display example



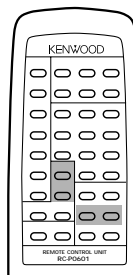

Hereafter the illustration of the common parts on the front panel is of CD-206/DPF-R6010.

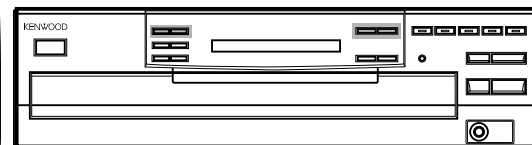

 : Keys and controls used in the operations described on this page.

Selecting the text information display (TEXT DISPLAY)

In the case of a CD-TEXT disc, the displays shown below can be selected.



TEXT DISPLAY

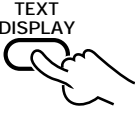

▶ Disc Title : AB

← Scroll display

▶ : ABCDEF. . .

- When there is no text information to be displayed "-----" is scrolled on the display.
- In the case of a non-CD-TEXT disc, the "NO CD TEXT" display will appear for approx. 3 seconds.

In the stop mode

When the key is pressed once, the ① "Disc Title" is scrolled on the display; when it is pressed repeatedly, the display is changed. (This operation cannot be performed in the PGM mode.)

- ▶ ① **Disc Title** : Disc title
- ▶ ② **Disc Artist** : Singer (or performer)
- ▶ ③ **TIME** : Disc No., track No., time display

- If the key is released while ② "Disc Artist" is displayed, ① "Disc Title" returns to the display.

In the play mode

When the key is pressed once, the ① "Track Title" is scrolled on the display; when it is pressed repeatedly, the display is changed.

- ▶ ① **Track Title** : Track title
- ▶ ② **Track Artist** : Singer (or performer)
- ▶ ③ **Disc Title** : Disc title
- ▶ ④ **Disc Artist** : Singer (or performer)
- ▶ ⑤ **TIME** : Track No., time display

- If the key is released at any point while ② "Track Artist" to ④ "Disc Artist" is displayed, ① "Track Title" returns to the display.

Displaying all the text information (ALL INFO.)

In the case of a CD-TEXT disc, the text information shown below is displayed automatically during normal play (TRACK mode).



ALL INFO.



← Scroll display

▶ Arranger : ABCD

To skip to the next track while the items are being displayed:
Press the ►► key.

- The display can be returned to a previous item by pressing the ◀◀ key.

Each item is displayed in turn each time the key is pressed. When the key is repeatedly pressed while an item is being displayed, the display is forcibly moved to the next item.

- ▶ ① **Disc/Track Title** : Disc and track titles
- ▶ ② **Disc/Track Artist** : Singer (or performer)
- ▶ ③ **Disc/Track Songwriter** : Songwriter
- ▶ ④ **Disc/Track Composer** : Composer
- ▶ ⑤ **Disc/Track Arranger** : Arranger
- ▶ ⑥ **Disc/Track Message** : Message from sponsor or artist
- ▶ ⑦ **ID INFO.** : Record company, release date, etc.
- ▶ ⑧ **Genre INFO.** : Genre information
- ▶ ⑨ **ALL INFO. END** : (Release)

- Items from ① to ⑥ are displayed in the sequence of disc and track.
- When there is no text information to be displayed "-----" is scrolled on the display.
- In the case of a non-CD-TEXT disc, the "NO CD TEXT" display will appear for approx. 3 seconds.

Programmed play (PGM mode)

CD-206/204/203/DPF-R6010/R4010/R3010 (En)

14

Use the following procedure to program desired tracks in a desired order. (up to 32 tracks)

Preparation

- Load a disc in the CD player.

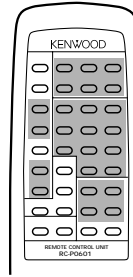

Hereafter the illustration of the common parts on the front panel is of CD-206/DPF-R6010.

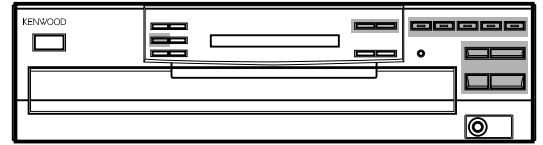

: Keys and controls used in the operations described on this page.

1 Press so that the "PGM" indicator lights.

Do this operation in the stop mode.

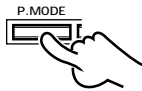

CD-206/DPF-R6010

Blinks.



CD-204/203/DPF-R4010/R3010

Light up.

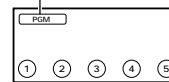

2 Program desired tracks.

1 Select the disc.



Go to step 2 within 8 seconds.

2 Select the desired track No.

Main unit

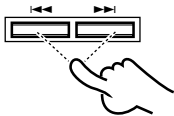

Remote control unit

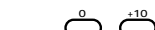
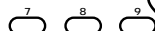
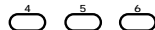
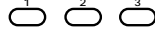

Go to step 3 within 8 seconds.

3 Set the entry.

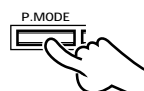

4 Repeat steps 1, 2 and 3 above.



In the case of a CD-TEXT disc, the disc title is scrolled on the display. (CD-206/DPF-R6010 only)

Press the numeric keys as shown below...

To enter track No. 25 : [+10] [+10] [5]

CD-206/DPF-R6010



In the case of a CD-TEXT disc, the track's title is scrolled on the display.



CD-204/203/DPF-R4010/R3010

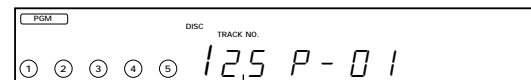

Track number

- Tracks can also be selected by pressing the ◀◀ or ▶▶ key.
- Up to 32 tracks can be programmed. When "FULL" is displayed, no more tracks can be programmed.
- If you make a mistake, press the CLEAR key and enter the track No. from the beginning.

3 Start playback.



- When the ◀◀ or ▶▶ key is pressed during playback, the track will be skipped in the direction of the pressed button.
- When the ◀◀ key is pressed once during playback, the play position returns to the beginning of the current track being played.

To stop playback

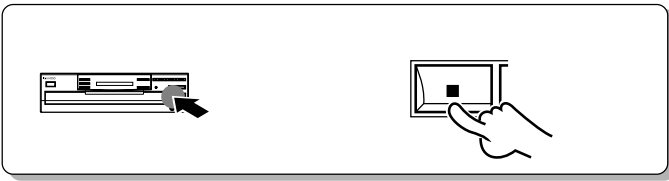

- The programmed contents remain in memory.

To check or change the programmed tracks

1 Press the CHECK key.

CD-206/DPF-R6010

CHECK

Press until the track No. to be changed is displayed.

CD-204/203/DPF-R4010/R3010

CHECK

Press until the track No. to be changed is displayed.

2 Select the disc.

3 Select the new track No.

Main unit

Remote control unit

4 Set the entry.

P.MODE

CD-206/DPF-R6010

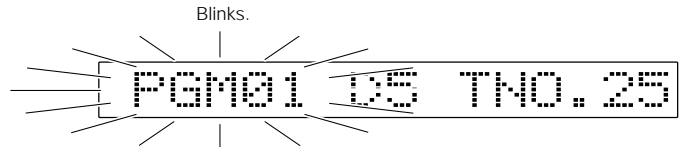

CD-204/203/DPF-R4010/R3010

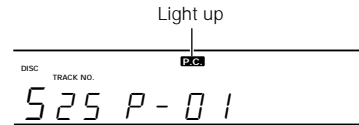

- Perform only step 1 to simply check the program.
- In the case of a CD-TEXT disc, the track's title is scrolled on the display. (CD-206/DPF-R6010 only)
- Each time the key is pressed, the program No. and the track No. on CD are displayed.

Example

- Press it while the "PGM01" indicator blinks. (CD-206/DPF-R6010 only)
- Press the key while the "P.C." indicator is lit. (CD-204/203/DPF-R4010/R3010 only)
- The track being played cannot be changed.

To add a track to the program

1 Select the disc.

2 Select the desired track No.

Main unit

Remote control unit

3 Press the P.MODE key.

- When a track No. is selected, the track will be added to the end of the existing program.

To clear tracks from the program

CD-206/DPF-R6010 Press to clear tracks from the end.



CD-204/203/DPF-R4010/R3010



To clear all tracks



- Each time the key is pressed, the last track in the program is cleared.
- The tracks which are programmed earlier than the track being played cannot be cleared.

- Selected tracks can be also completely cleared just by operating the ▲ key.
- The entire program is cleared.

To program all tracks on a disc (CD-204/203/DPF-R4010/R3010 only)

① Press so that the "PGM" indicator lights.



② Select the desired disc.

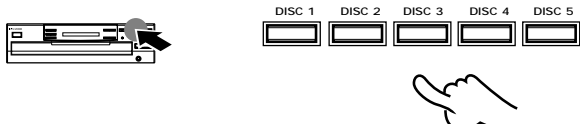

③ Press the P. MODE key again.

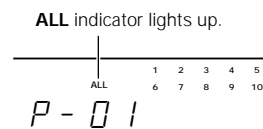
Auto space function

During programming of tracks, a non-recorded space of a few seconds will be automatically created between tracks. By recording tracks with these spaces on tape, the search and repeat play operations of tape using the DPSS function (which works by searching the non-recorded spaces) can be performed reliably.

- Even when the performances of two tracks are continuous (which occurs with classical or live recording music), the spaces will be created if they have different track Nos.

Time display on CD player (TIME DISP.)

Each press of the TIME DISP. (TIME DISPLAY) key changes the displayed contents.

Do this operation in the play mode.



CD-206/DPF-R6010

- ① 1:23 : Elapsed time of track being played
- ② -2:23 : Remaining time of track being played
- ③ 23:45T : Elapsed time of entire disc (T lights up.)
- ④ -36:25T : Remaining time on entire disc (T lights up.)

CD-204/203/DPF-R4010/R3010

- ① 1:23 : Elapsed time of track being played (SINGLE lights up.)
- ② -2:23 : Remaining time of track being played (SINGLE lights up.)
- ③ 23:45 : Elapsed time of entire disc (TOTAL lights up.)
- ④ -36:25 : Remaining time on entire disc (TOTAL lights up.)

- Only the display ① and ② will be displayed in PGM, RANDOM and EDIT modes.

Playback in a random order (Random playback)

CD-206/204/203/DPF-R6010/R4010/R3010 (En)

As tracks are selected at random, you can enjoy listening to for a long time.

Preparation • Load a disc in the CD player.

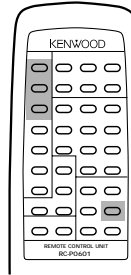

Hereafter the illustration of the common parts on the front panel is of CD-206/DPF-R6010.

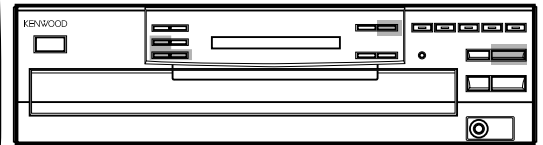

 : Keys and controls used in the operations described on this page.

1 Check that the unit is in the normal play **TRACK** mode. → 

2 Press the **RANDOM** key.

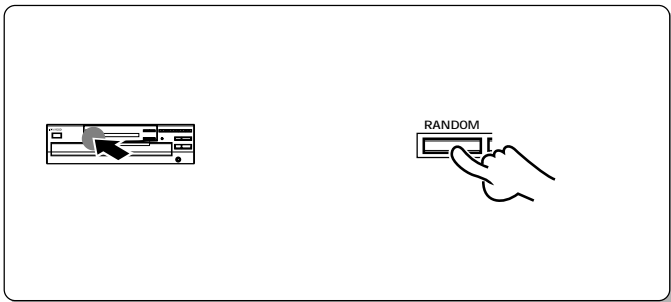

CD-206/DPF-R6010

During track selection: ">" and "<" move from the outside to the inside.

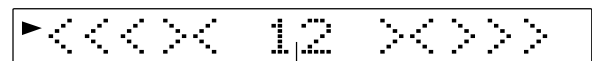

↓ The number here changes.



In case track No. 5 is selected

CD-204/203/DPF-R4010/R3010

During random track selection

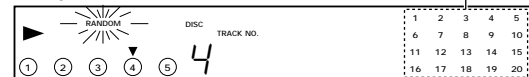

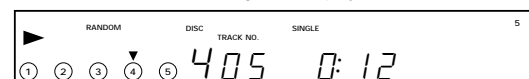

To select another track during random play

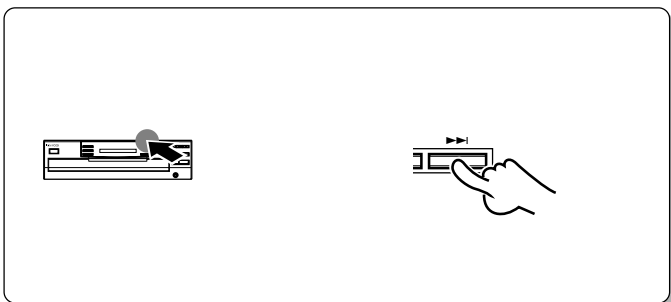

- Each time a track ends, the same operation as above is repeated, and the track selected next is played.
- Random play stops after all of the tunes have been played once.
- The random playback can also be repeated by pressing the **REPEAT** key.

To select another track in the middle of playing one



- Pressing the  key once returns to the beginning of the track being played.

To cancel random playback

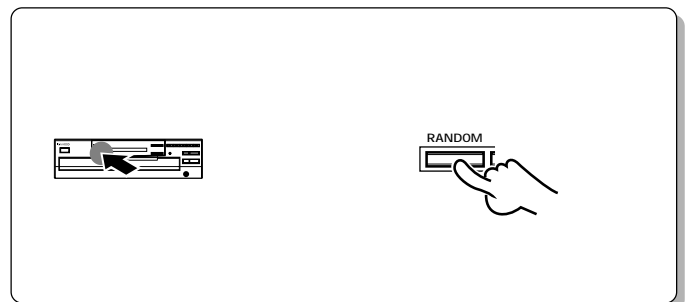

- Press the **RANDOM** key to start normal playback.

Repeated playback

CD-206/204/203/DPF-R6010/R4010/R3010 (En)

18

Preparation • Load a disc in the CD player.

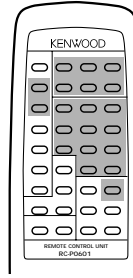

Hereafter the illustration of the common parts on the front panel is of CD-206/DPF-R6010.

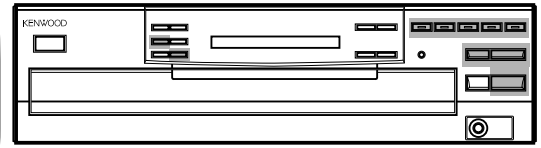

: Keys and controls used in the operations described on this page.

To repeat only the programmed tracks

1 Press so that the "PGM" indicator lights.



2 Select the disc.

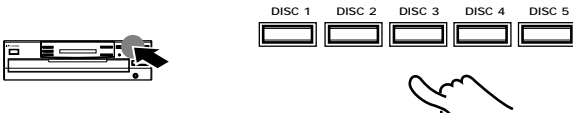

Go to step 3 within 8 seconds.

3 Select the desired track number.

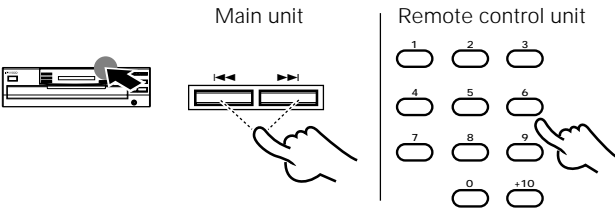

Go to step 4 within 8 seconds.

4 Set the entry.



5 Repeat steps 2 - 4 above.

6 Press the REPEAT key.



For the CD-206/DPF-R6010

The current status is displayed when the key is pressed once.

When it is pressed while the status is displayed, the repeat ON status can be set to OFF (or vice versa).

7 Start playback.



CD-206/DPF-R6010



CD-204/203/DPF-R4010/R3010

PGM indicator light up.



- All of the programmed tracks will be repeated.
- In case only one track is programmed, only that track will be repeated.
- Up to 32 tracks can be programmed. When "FULL" is displayed, no more tracks can be programmed.

CD-206/DPF-R6010



CD-204/203/DPF-R4010/R3010

REPEAT indicator light up.

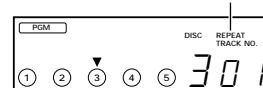

To repeat one of the discs (CD-204/203/DPF-R4010/R3010 only)

- 1 Press so that the "PGM" indicator lights.
- 2 Select the disc.
- 3 Press the P.MODE key.
- 4 Press the REPEAT key.
- 5 Start playback.

PGM indicator light up.

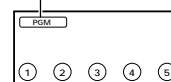

REPEAT indicator light up.

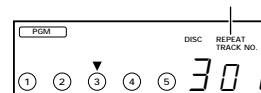

To repeat the entire disc

This allows repeated playback of all the tracks on the disc loaded in the disc tray.

- 1 Press so that the "PGM" indicator goes off.
- 2 Press the REPEAT key.
- 3 Start playback.

For the CD-206/DPF-R6010
The current status is displayed when the key is pressed once.
When it is pressed while the status is displayed, the repeat ON status can be set to OFF (or vice versa).

CD-206/DPF-R6010



CD-204/203/DPF-R4010/R3010

PGM indicator goes off.

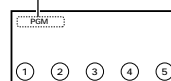

CD-206/DPF-R6010



CD-204/203/DPF-R4010/R3010

REPEAT indicator light up.

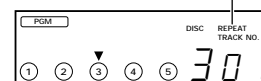

To cancel repeated playback

Press the REPEAT key.

For the CD206/DPF-R6010
Press the REPEAT key once again.
(REPEAT ON → OFF)

CD-206/DPF-R6010



CD-204/203/DPF-R4010/R3010

REPEAT indicator goes off.

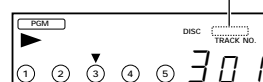

Editing

CD-206/204/203/DPF-R6010/R4010/R3010 (En)

20

The following procedure allows to record a CD within the specified tape length so that no music is interrupted in the middle at the ends of sides A and B.

Normal EDIT: Edit from one disc.

MULTI EDIT: Edit and record from several discs.

Preparation

- Load a disc in the CD player.
- Check that the unit is in the normal play TRACK mode.

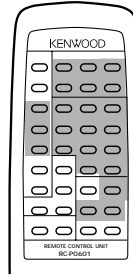

Hereafter the illustration of the common parts on the front panel is of CD-206/DPF-R6010.

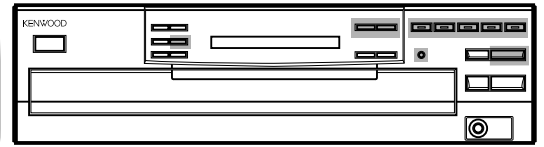

: Keys and controls used in the operations described on this page.

Normal EDIT

1 Light the "EDIT" indicator.

Do this operation in the stop mode.



Go to step 2 within 8 seconds.
If more than 8 seconds have elapsed, press the key again.

CD-206/DPF-R6010

Blinks.



CD-204/203/DPF-R4010/R3010

Light up.



2 Select the disc.



Go to step 3 within 8 seconds.

3 Enter the recording time of the tape.

When using the numeric keys:

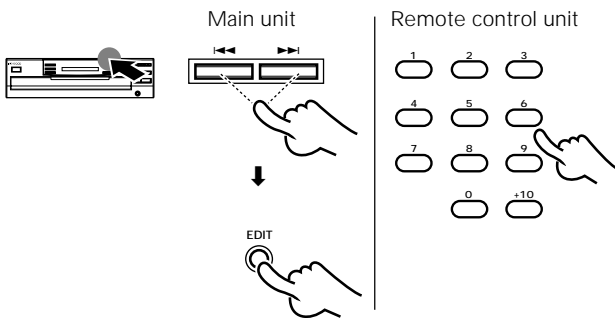

When using the TIME DISPLAY key:

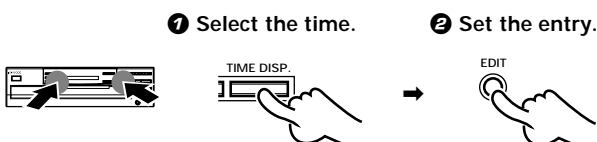

Press the numeric keys as shown below.

30-minute tape :

46-minute tape :

CD-206/DPF-R6010

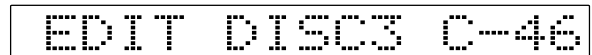

CD-204/203/DPF-R4010/R3010

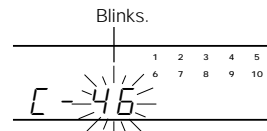

- The interval length can be adjusted with the skip keys and in units of one minute (to a maximum of 99 minutes).
- If you commit a mistake in time entry, press the P.MODE key and restart the procedure from the beginning.

CD-206/DPF-R6010

- By pressing the TIME DISPLAY key the set time-length intervals will change in this order: "46→54→60→74→90→??"

CD-204/203/DPF-R4010/R3010

- By pressing the TIME DISPLAY key the set time-length intervals will change in this order: "46→54→60→90→..."

- Automatic editing is executed for side A and side B,

Several CDs can be edited and recorded on 1 tape. Choose songs from each disc, and edit/record while confirming the remaining time on files A and B, respectively.

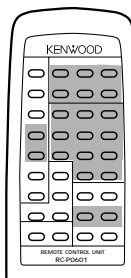

Hereafter the illustration of the common parts on the front panel is of CD-206/DPF-R6010.

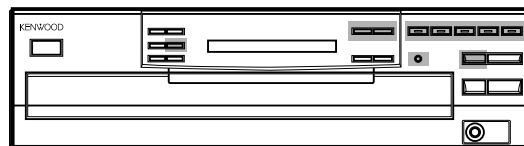



 : Keys and controls used in the operations described on this page.

MULTI EDIT (Except for CD-206/DPF-R6010)

1 Press so that the "MULTI EDIT" indicator light.

Do this operation in the stop mode.

Press twice

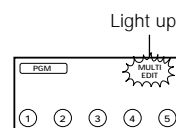

2 Enter the recording time of the tape. →  20

3 Select the desired track.

1 Select the disc (one disc only).

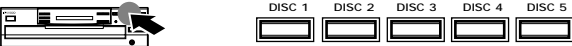

2 Select the tracks to be recorded.

Main unit

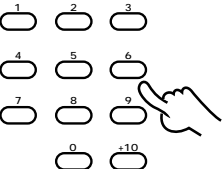
Remote control unit

P.MODE

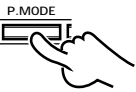

- If you made a mistake, press the **CLEAR** key and select the correct track.
- The time remaining on side A or side B is indicated on the display.
- When the time left on side A is less than the play time of the selected song, that song will be programmed on side B.
- If "FULL" is displayed, no further programming can be accepted.

4 Start recording.

When recording with a cassette deck equipped with CCRS function:

Press the CCRS key (Cassette deck).

When recording with a normal cassette deck:

- 1 Adjust the recording levels.
- 2 Press the record key.
- 3 Play the CD.

- With the CCRS function, the recording starts after about 1 minute.
- If you have a cassette deck capable of Double-speed recording, use Normal-speed recording.

5 Repeat step 3, 4 above.

- Change discs and, if the "b-01" indication is given when you first select a song, turn the tape to the start of side B.

To check the edited contents

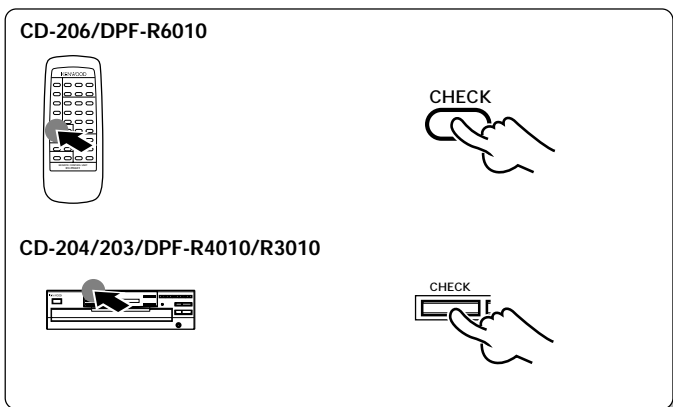

CD-206/DPF-R6010



- When the **CHECK** key is pressed, track numbers and remaining time in the file A are displayed first, then those in the file B.

CD-204/203/DPF-R4010/R3010

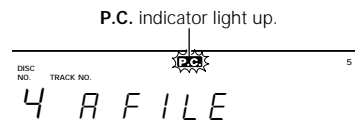

During normal EDIT:

- When the **CHECK** key is pressed, the track Nos. of edited songs will automatically be displayed in the order they are edited.

During MULTI EDIT:

- Every time the **CHECK** key is pressed, the track Nos. are displayed in the edited order.

Playing or recording the edited contents

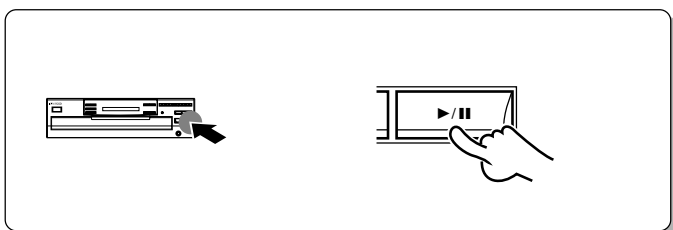

When recording the edited content onto a tape, it is recommended to use the **synchro recording** or **CCRS recording function** of **KENWOOD** cassette decks.

- Do not adjust the output level from this unit particularly during recording.
- For details, see the instruction manual of the cassette deck.



Press the ►/|| key to start playback according to the edited content. The playback pauses at the beginning of the track edited for tape side B. Press the ►/|| key again to continue playback.

To clear the edited contents

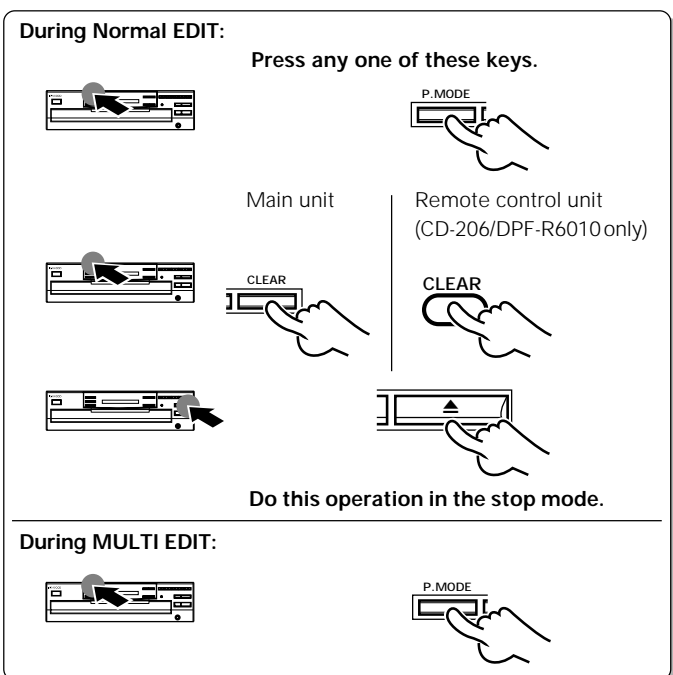

- The edited data is cleared entirely.



- While you can edit with a different time setting to that of the tape you are using, part of the tape may be left with nothing recorded on it, or the last track on side A or side B may be cut short.
- The EDIT function may not operate properly for discs having only one track or having tracks of long duration such as classical music.

Timer operations

Timer playback of CD can be started at any time using an audio timer which is available in audio stores.

Preparation

- Connect the power cords of the associated components so that their power can be turned ON through the audio timer. (Also, be sure to read carefully the instruction manual of the timer.)

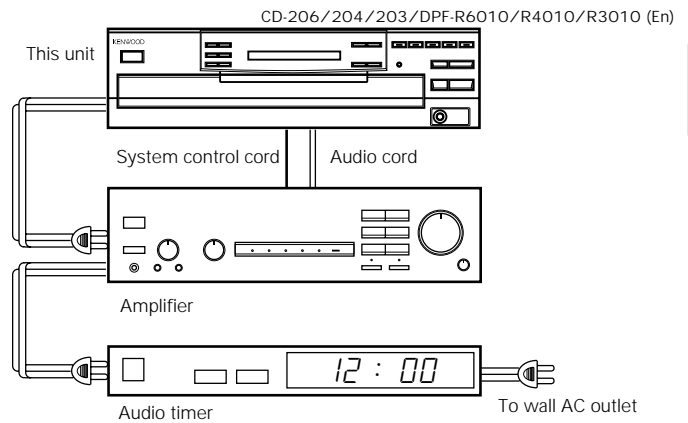

1 Turn the powers of the associated components ON.

2 Preparation

Load a disc in the CD player.

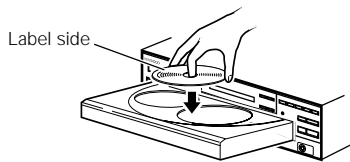

3 Set the amplifier volume.

1 Play the disc.



2 Adjust the amplifier volume.
(Use the remote control unit (Except CD-203/DPF-R3010) of this unit to adjust the volume to the maximum level.)

3 Stop the disc.



4 Set the timer ON time.

Set the timer so that it supplies power at the specified time.

5 Turn OFF the power output from the audio timer.

- If the amplifier is not connected to the CD player through a system control cord, select the "CD" input with the input selector.

Note **Adjusting the volume:**
Set the volume the maximum (0 dB) using the OUTPUT (UP) key on the remote control unit (Except CD-203/DPF-R3010), and adjust the volume to the desired level on the amplifier side.
(Since the sound output is at the maximum level when the power is turned on, lowering the level with the remote control unit will change the volume.)

- With some audio timer models, the power is automatically turned OFF when the timer ON time is set. With such a model, skip step 5 below.

- Do not touch the ON/STANDBY (POWER/I/⏻) switches of the amplifier and CD player.
- When the set time comes, the disc playback starts automatically.



1. Some amplifiers cannot be used with a timer. Before using an amplifier, check it.
2. When operating the unit other than CD player using an audio timer, be sure to remove the disc from the CD player.

Disc handling precautions

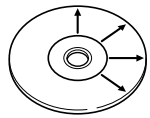
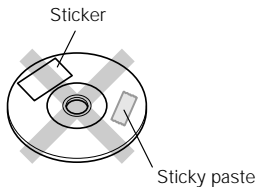
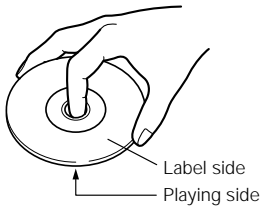

Handling

Hold compact discs so that you do not touch the playing surface.

- Do not attach paper or tape to either the playing side or the label side of compact discs.
- The paste left on the label surface after a sticker has been peeled off is a factor which may cause malfunction. If the surface is sticky due to remaining paste, be sure to clean it with alcohol before use.

Cleaning

If fingerprints or foreign matter become attached to the disc, lightly wipe the disc with a soft cotton cloth (or similar) from the center of the disc outwards, in a radial manner.

Storage

When a disc is not to be played for a long period of time, remove it from the CD player and store it in its case.

Discs which can be played with this unit

CD (12 cm, 8 cm) (CD-TEXT support), CDV (only the audio part)

- With CD-G (CD Graphics) discs, this unit can play only the audio part.

Never play a cracked or warped disc.

During playback, the disc rotates at high speed in the player.

Therefore, to avoid danger, never use a cracked or deformed disc or a disc repaired with tape or adhesive agent.

Please do not use discs which are not round because they may cause a malfunction.

CD accessories

The CD accessories (stabilizer, protection sheet, protection ring, etc.) which are marketed for improving the sound quality or protecting discs as well as the disc cleaner should not be used with this system because they may cause malfunction.

Cleaning

Do not use volatile solvents such as alcohol, paint thinner, gasoline, or benzene, etc. to clean the cabinet. Use a clean dry cloth.

Do not use contact cleaners because it could cause a malfunction. Be specially careful against contact cleaners containing oil, for they may deform the plastic components.

Caution on condensation

Condensation (of dew) may occur inside the unit when there is a great difference in temperature between this unit and the outside.

This unit may not function properly if condensation occurs. In this case, leave the unit for a few hours with the power left ON, and restart the operation after the condensation has dried up.

Be specially cautious against condensation in a following circumstance:

When this unit is carried from a place to another across a large difference in temperature, when the humidity in the room where this unit is installed increases, etc.

Note related to transportation and movement

Before transporting or moving this unit, carry out the following operations.

1. Turn the unit ON but do not load a disc.
2. Wait a few seconds and verify that the display shown appears.

CD-206/DPF-R6010



CD-204/203/DPF-R4010/R3010



3. Press the ▲ OPEN/CLOSE key to open the disc tray completely.
4. Press the ▲ OPEN/CLOSE key again to close the tray.
5. Wait a few seconds and set the unit to STANDBY mode.

In case of difficulty

What appears to be a malfunction may not always be serious. If your unit should not perform as expected, consult the table below to see if the problem can be corrected before seeking help from your dealer or service representative.

Operation to reset

The microcomputer may malfunction (impossibility to operate, erroneous display, etc.) when the connection cords are unplugged while the unit is ON or due to an external factor. In this case, execute the following method to reset the microcomputer and return it to normal condition.

Unplug the power cord from the power socket and plug the power cord into the socket again.

- Please be aware that resetting the CD player will erase all stored information and return it to the factory settings.

CD player unit

Symptom	Cause	Remedy
The unit is not turned ON with the ON/STANDBY (POWER/I / ⏻) switch ON.	<ul style="list-style-type: none"> ● Power plug is loosely connected. ● With the power plug connected to the switched AC outlet of an amplifier, the power of the amplifier is turned off. 	<ul style="list-style-type: none"> ● Insert the power plug firmly to the AC outlet. ● Turn the amplifier's power ON.
There is no sound even when a disc is loaded.	<ul style="list-style-type: none"> ● Disc is loaded upside down. ● Disc is loose. ● Disc is dirty. ● Disc is cracked. ● Condensation has occurred on the optical lens unit. ● Play mode is not entered. ● The connection cords are inserted loosely. ● Output level is attenuated too low. 	<ul style="list-style-type: none"> ● Load the disc again with its label side up. ● Insert disc properly. ● Wipe off the dust on the surface of the disc referring to "Disc handling precautions" . → 24 ● Replace the disc with a new one. ● Remove any condensation from the unit by referring to the section entitled, "Caution on condensation" . → 24 ● Press the ▶/⏸ key. ● Connect all connection cords firmly. ● Adjust the output level with OUTPUT key on the remote control unit. → 5
Music is interrupted. (Sound is skipped.)	<ul style="list-style-type: none"> ● Disc is too dirty. ● Disc is cracked. ● Oscillation is applied to this unit. 	<ul style="list-style-type: none"> ● Wipe off the dust on the disc surface referring to "Disc handling precautions" . → 24 ● Replace the disc with a new one. ● Try selecting a place where no strong vibrations occur by changing the installation place, etc.
Play begins as soon as the unit is turned ON.	<ul style="list-style-type: none"> ● This unit is designed so that play begins automatically when the unit is turned ON if a disc is already loaded. 	<ul style="list-style-type: none"> ● If automatic play is not required remove the disc from the player before setting the unit to STANDBY mode.

Remote control unit

Symptom	Cause	Remedy
Remote control operation is not possible.	<ul style="list-style-type: none"> ● Batteries are exhausted. ● The remote control unit is too far away from the main system, controlling angle is too large, or there is an obstacle in between. 	<ul style="list-style-type: none"> ● Replace with new batteries. → 8 ● Operate the remote control unit within the controllable range. → 8

For the U.S.A.

CAUTION:

Use of controls or adjustment or performance of procedures other than those specified herein may result in hazardous radiation exposure.

In compliance with Federal Regulations, following are reproductions of labels on, or inside the product relating to laser product safety.

KENWOOD CORPORATION
2967-3, ISHIKAWA-CHO, HACHIOJI-SHI,
TOKYO, JAPAN

KENWOOD CORP. CERTIFIES THIS EQUIPMENT
CONFORMS TO DHHS REGULATIONS NO. 21
CFR 1040.10, CHAPTER I, SUBCHAPTER J.

Location: Back Panel

CD-206/DPF-R6010

[Format]

System Compact disc digital audio system
Laser Semiconductor laser

[D/A Convertors]

D/A Conversion 1 Bit (D.R.I.V.E.)
Oversampling 8 fs (352.8 kHz)

[Audio]

Frequency response 4 Hz – 20 kHz, ±0.5 dB
Signal to noise ratio More than 100 dB
Dynamic range More than 95 dB
Total harmonic distortion + noise
..... Less than 0.005% (at 1 kHz)

Wow & flutter Unmeasurable Limit

Output level/impedance

Variable (Max.) 2 V/0.3 kΩ

Digital output

Coaxial 0.5 V p-p / 75 Ω

Optical -15 dBm – -21 dBm
(Wave length 660 nm)

Headphone output (Max.) 20 mW (32 Ω)

[General]

Power consumption 14 W

Dimensions W: 440 mm (17-5/16")
H: 125 mm (4-15/16")
D: 397 mm (15-5/8")

Weight (Net) 5.0 kg (11.0 lb)

CD-204/203/DPF-R4010/3010

[Format]

System Compact disc digital audio system
Laser Semiconductor laser

[D/A Convertors]

D/A Conversion 1 Bit
Oversampling 8 fs (352.8 kHz)

[Audio]

Frequency response 4 Hz – 20 kHz, ±0.5 dB
Signal to noise ratio More than 95 dB
Dynamic range More than 95 dB
Total harmonic distortion + noise
..... Less than 0.008% (at 1 kHz)

Wow & flutter Unmeasurable Limit

Output level/impedance

Fixed (CD-203/DPF-R3010) 2 V/0.8 kΩ

Variable (CD-204/DPF-R4010) (Max.) 2 V/0.3 kΩ

Headphone output (Max.)

(CD-204/DPF-R4010 only) 20 mW (32 Ω)

[General]

Power consumption 13 W

Dimensions W: 440 mm (17-5/16")
H: 125 mm (4-15/16")
D: 397 mm (15-5/8")

Weight (Net) 5.0 kg (11.0 lb)



1. KENWOOD follows a policy of continuous advancements in development. For this reason specifications may be changed without notice.
2. The full performance may not be exhibited in an extremely cold location (under a water-freezing temperature).

For the U.S.A.

FCC WARNING:

This equipment may generate or use radio frequency energy. Changes or modifications to this equipment may cause harmful interference unless the modifications are expressly approved in the instruction manual. The user could lose the authority to operate this equipment if an unauthorized change or modification is made.

NOTE:

This equipment has been tested and found to comply with the limits for a Class B digital device, pursuant to Part 15 of the FCC Rules. These limits are designed to provide reasonable protection against harmful interference in a residential installation. This equipment may cause harmful interference to radio communications, if it is not installed and used in accordance with the instructions. However, there is no guarantee that interference will not occur in a particular installation. If this equipment does cause harmful interference to radio or television reception, which can be determined by turning the equipment off and on, the user is encouraged to try to correct the interference by one or more of the following measures:

- Reorient or relocate the receiving antenna.
- Increase the separation between the equipment and receiver.
- Connect the equipment into an outlet on a circuit different from that to which the receiver is connected.
- Consult the dealer or an experienced radio/TV technician for help.

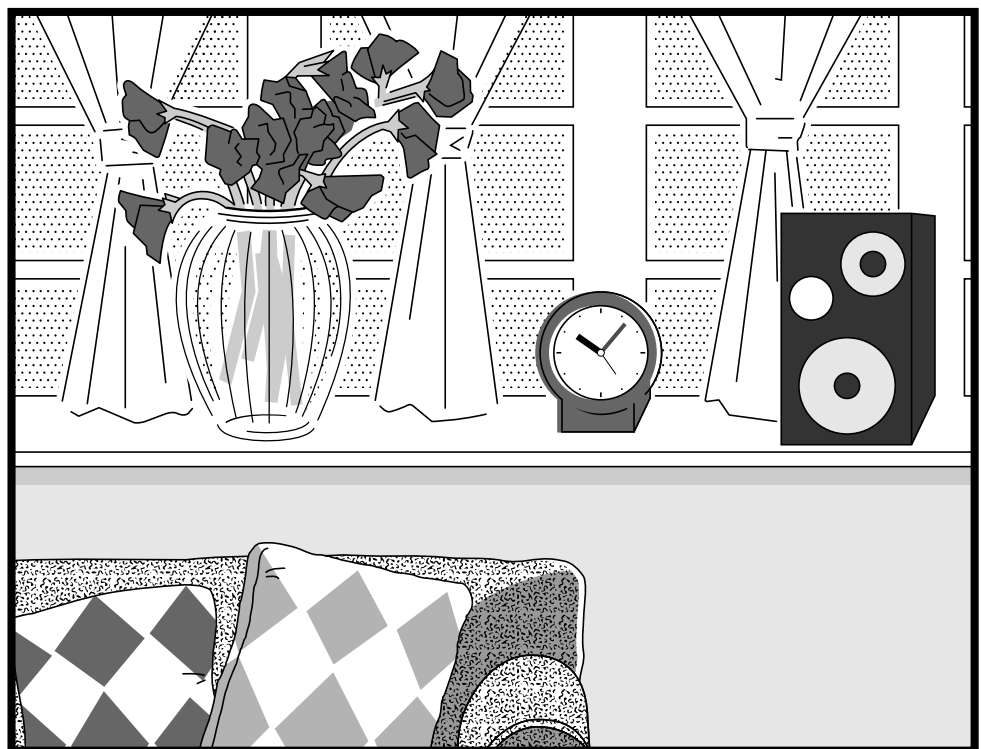

KENWOOD

For your records

Record the serial number, found on the back of the unit, in the spaces designated on the warranty card, and in the space provided below. Refer to the model and serial numbers whenever you call upon your dealer for information or service on this product.

Model _____ Serial Number _____